

ノーブルB-I

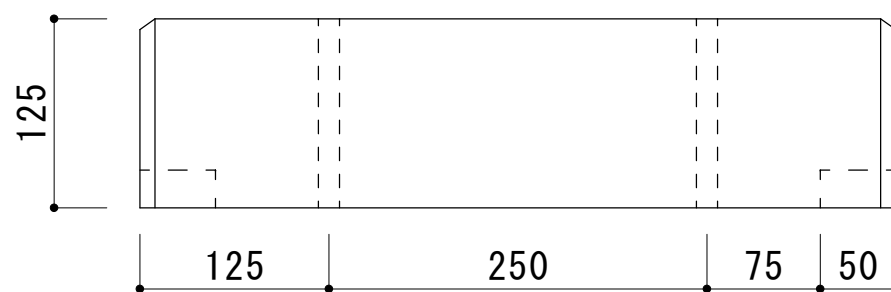

品名	ノーブルB-I (オーテックス)
寸法 (mm)	250 × 500 × 125
重量	19kg

ノーブルB-Ⅱ

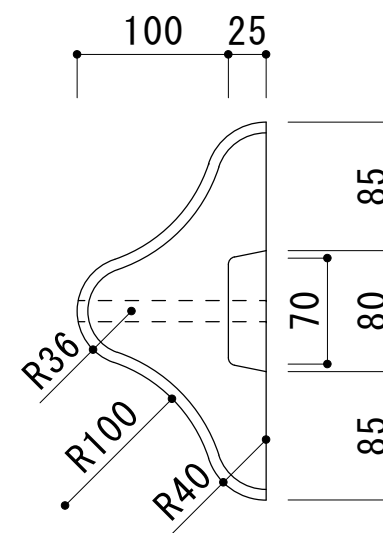
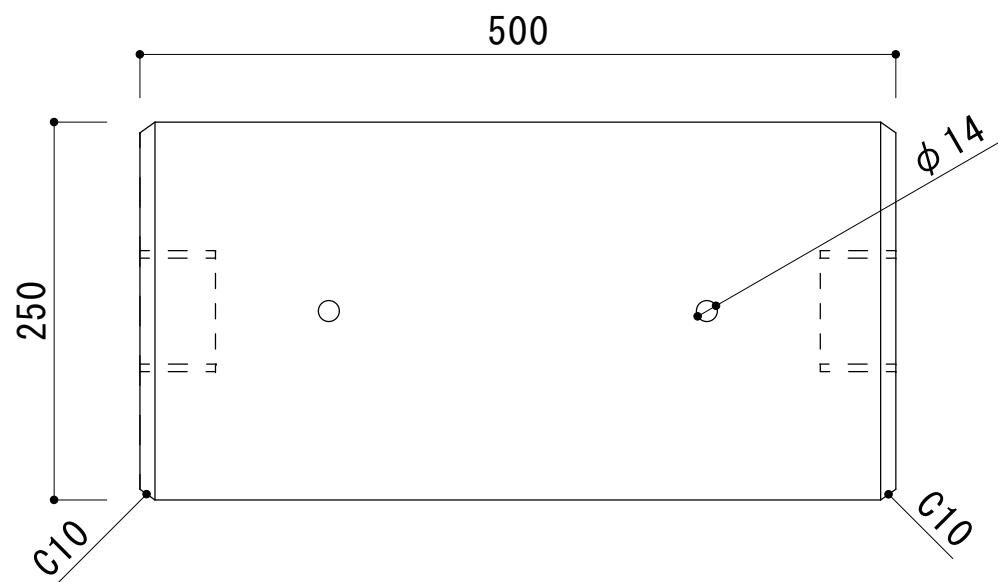
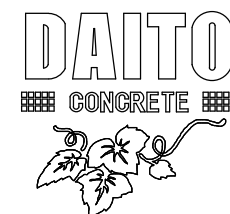
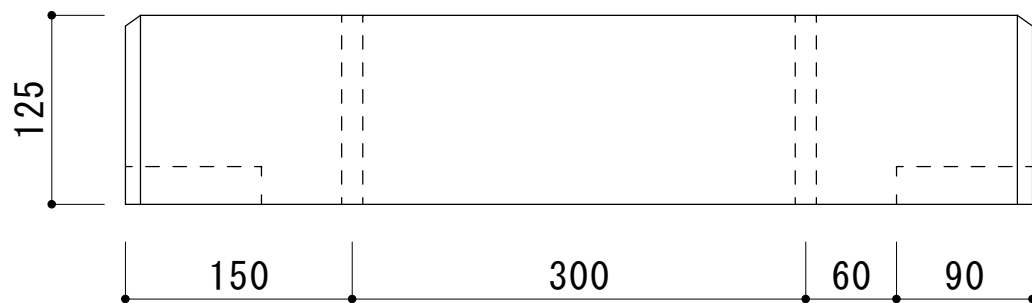
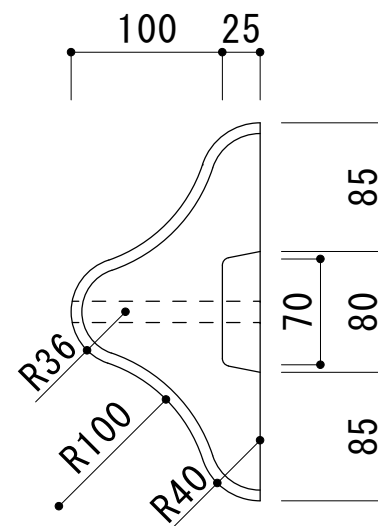
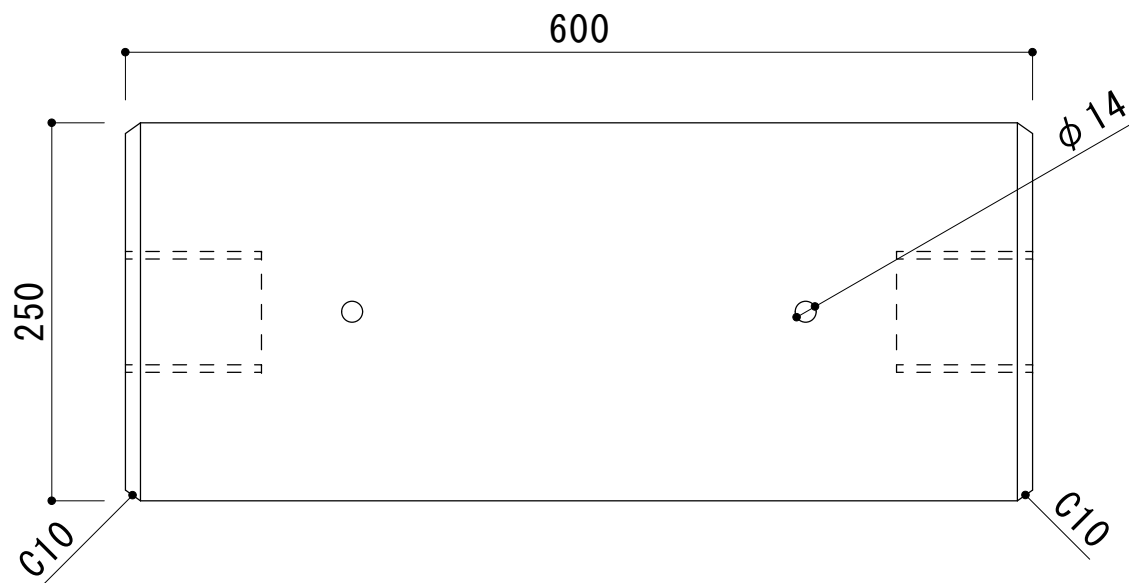
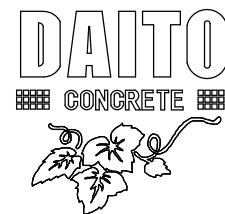

品名	ノーブルB-Ⅱ (オーテックス)
寸法 (mm)	250 × 600 × 125
重量	23kg

ノーブルB-Ⅲ

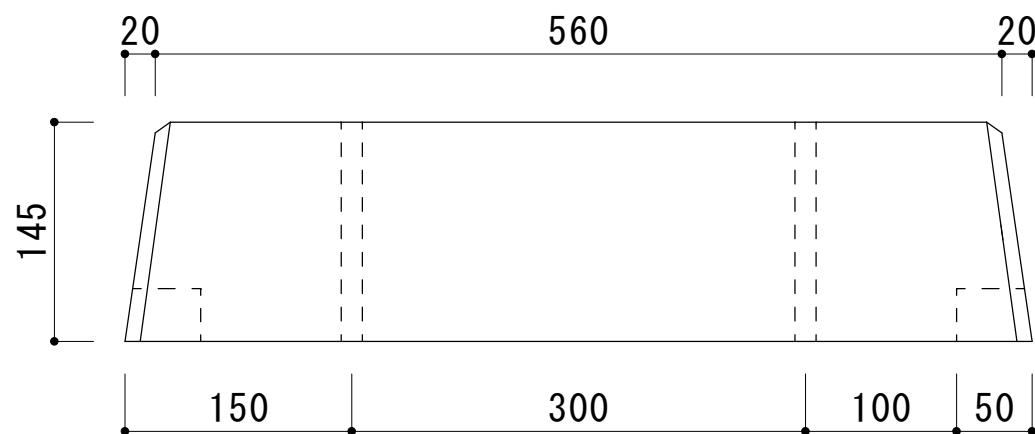
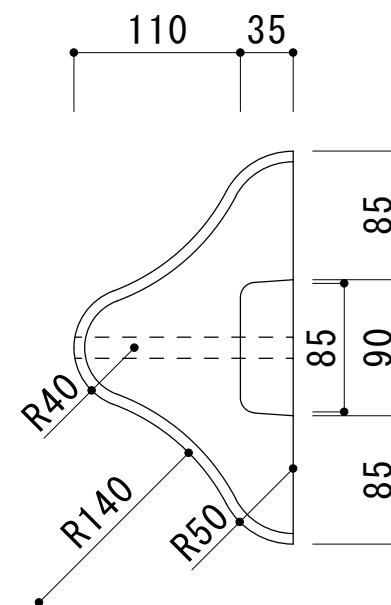
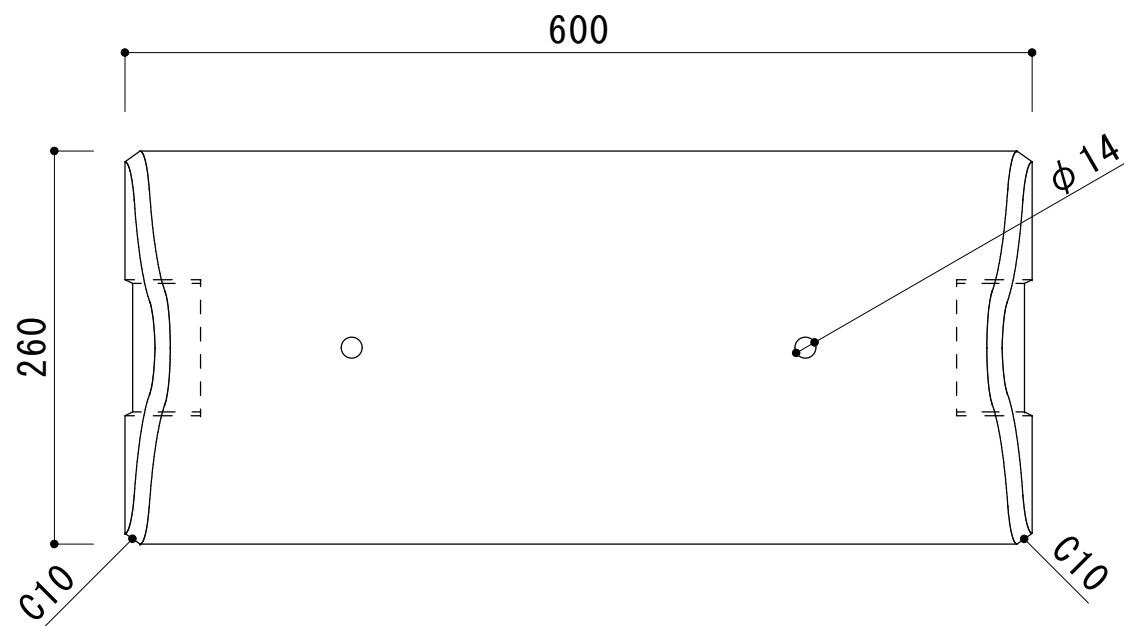
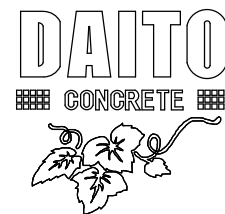

品名	ノーブルB-Ⅲ (オーテックス)
寸法 (mm)	260 × 600 × 145
重量	27kg

ノーブル500

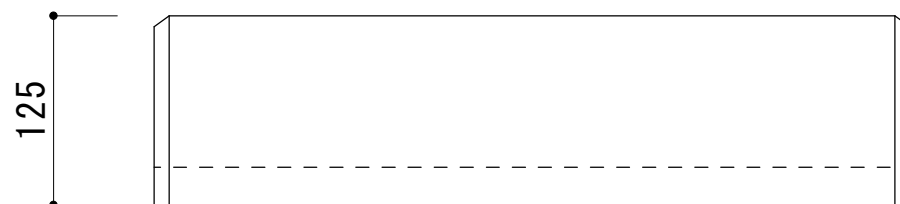
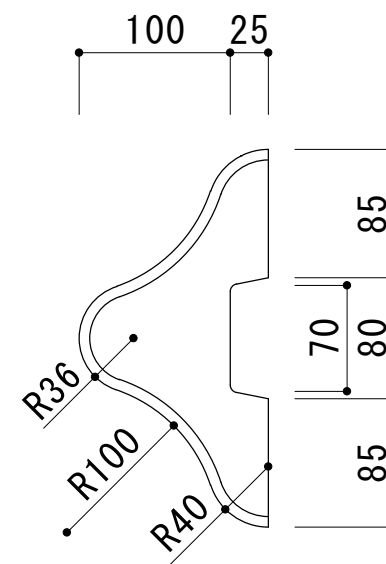
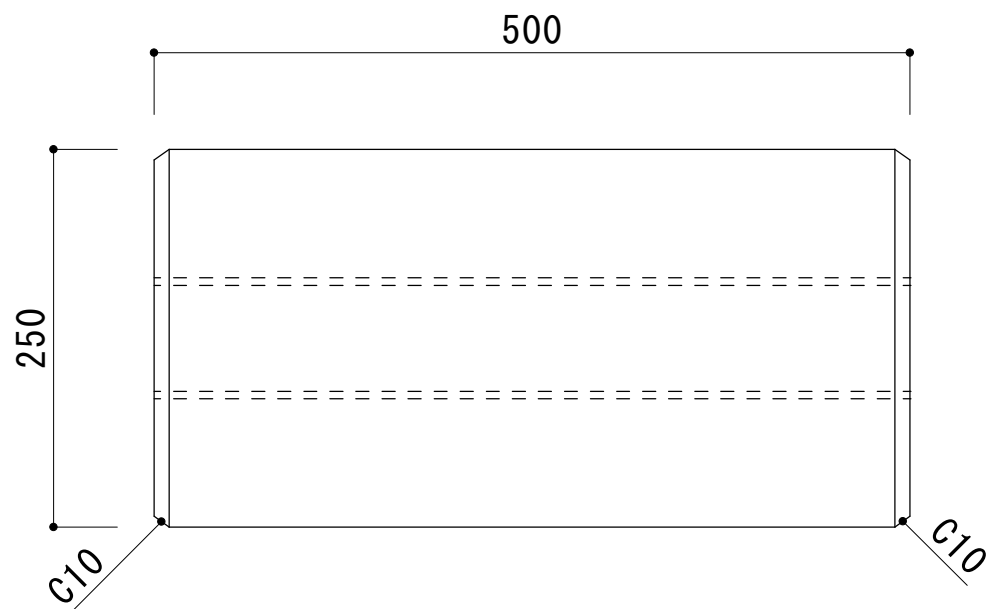
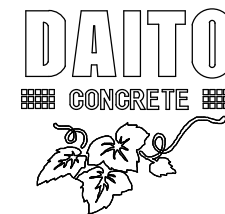

品名	ノーブル500 (オーテックス)
寸法 (mm)	250 × 500 × 125
重量	17kg

ノーブル600

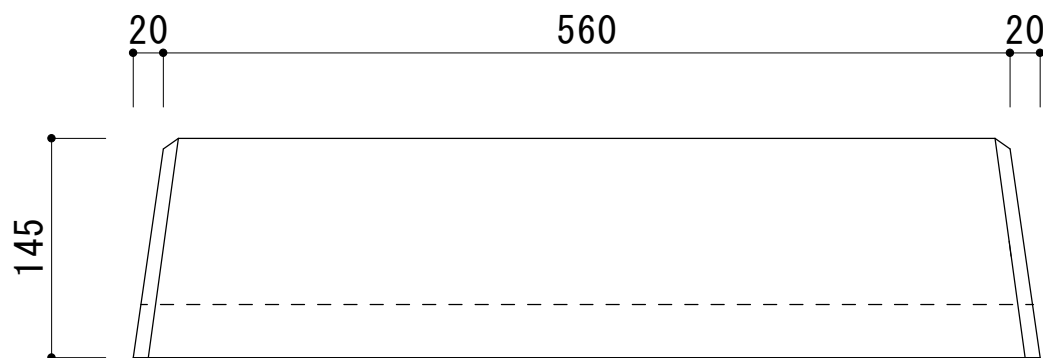
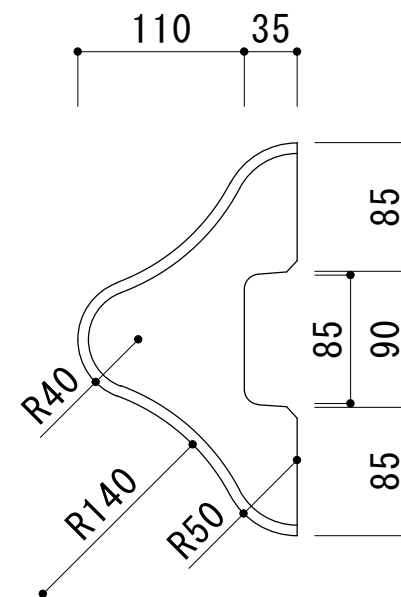
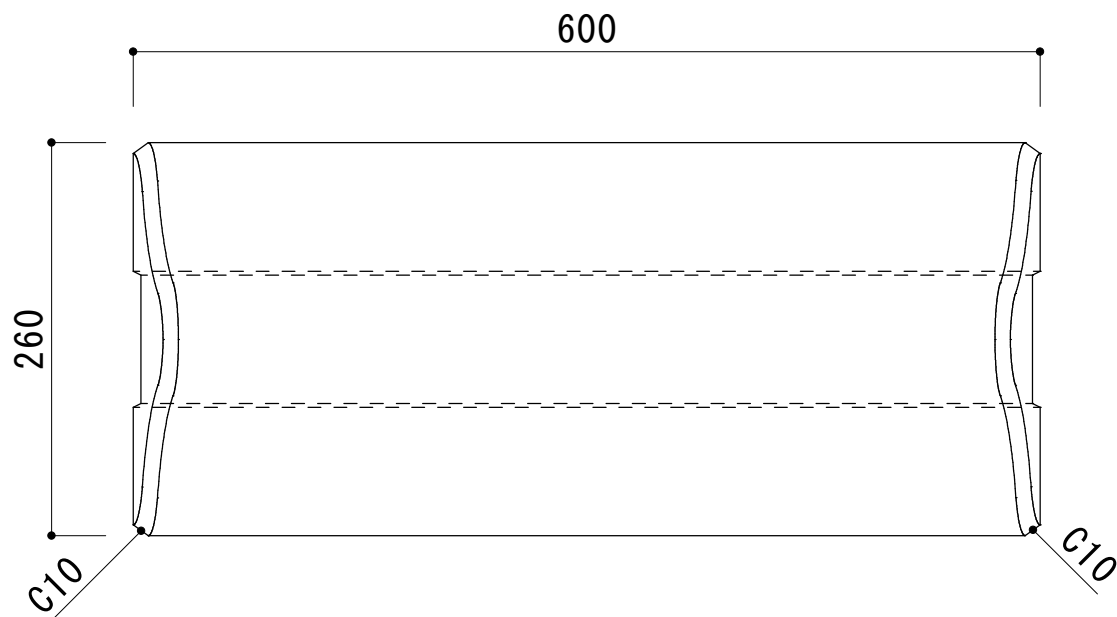
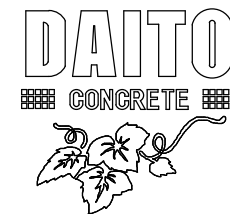

品名	ノーブル600 (オーテックス)
寸法 (mm)	260 × 600 × 145
重量	24kg

ノーブル600A

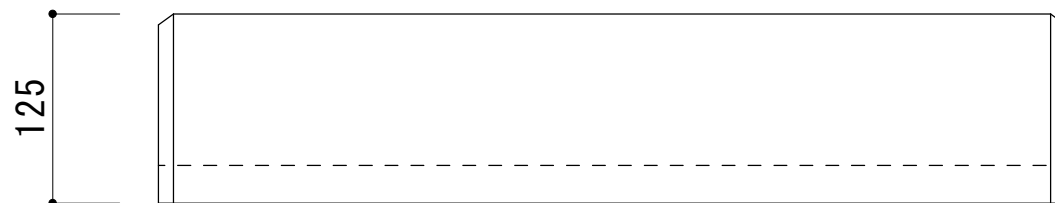
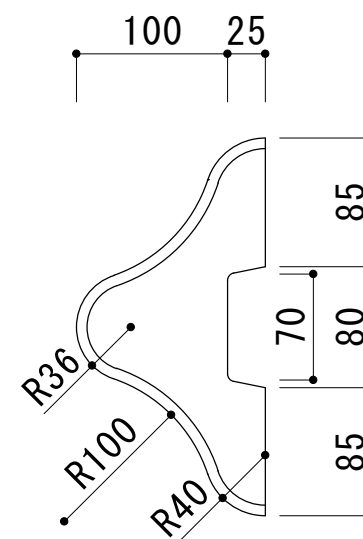
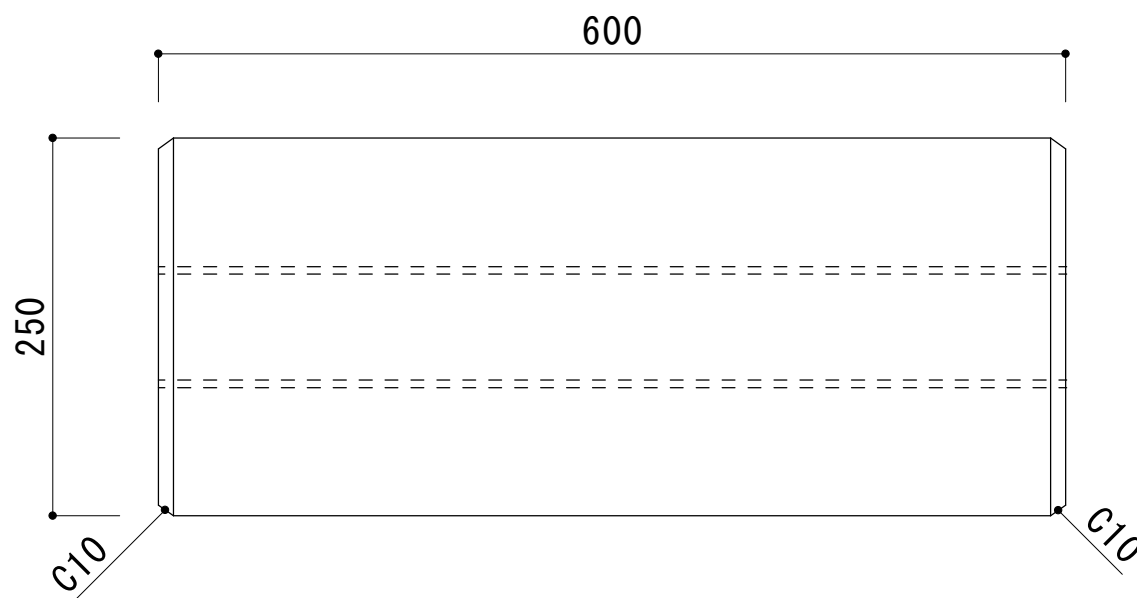
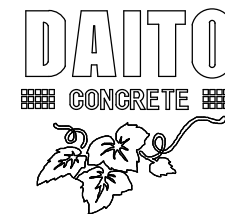

品名	ノーブル600A (オーテックス)
寸法 (mm)	250 × 600 × 125
重量	21kg

ノーブル600K

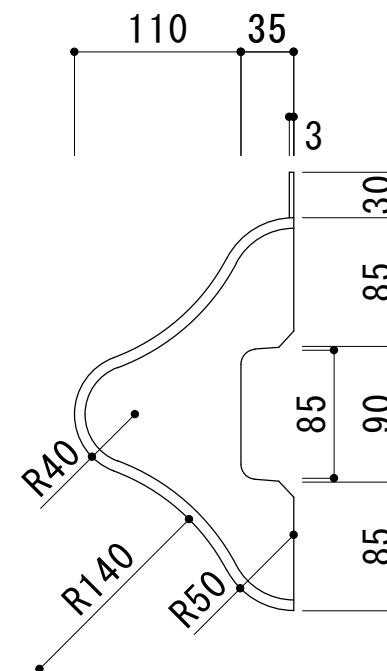
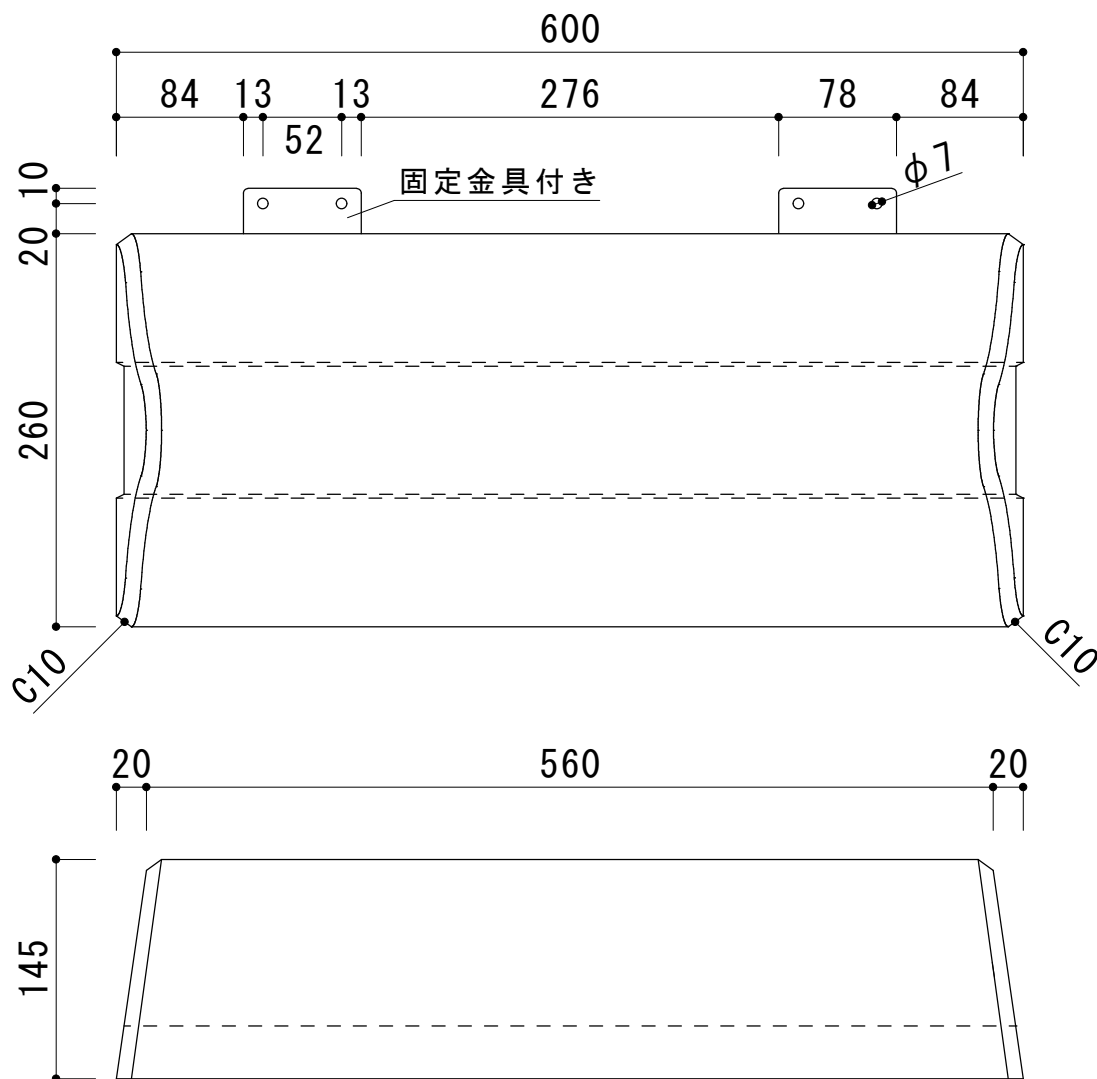
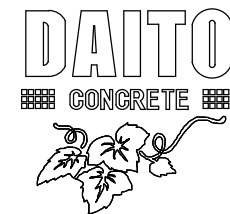

品名	ノーブル600K (オーテックス)
寸法 (mm)	260 × 600 × 145
重量	24kg

ストッピャ

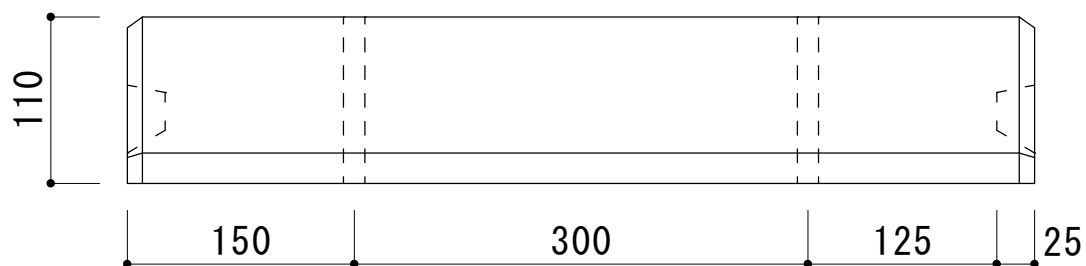
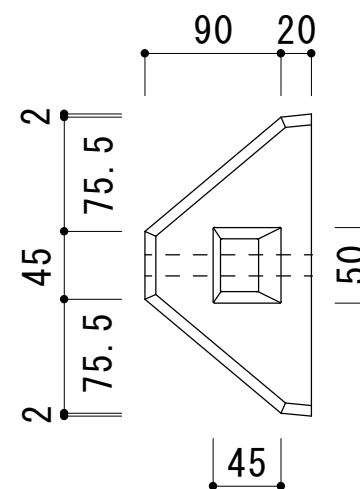
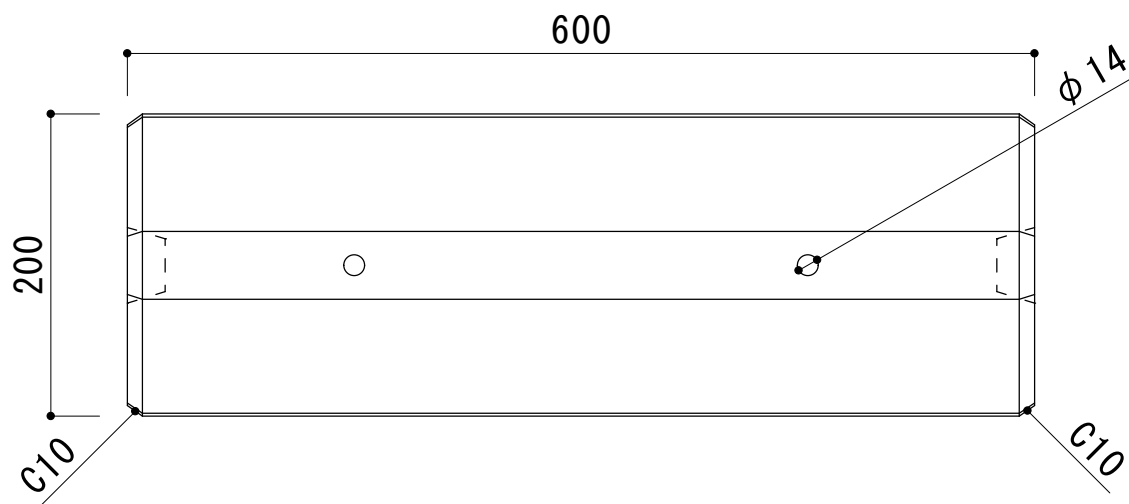
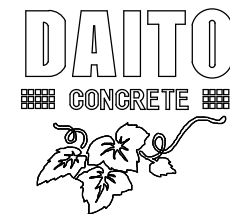

品名	ストッピャ (オーテックス)
寸法 (mm)	200 × 600 × 110
重量	19kg

ストッパー R

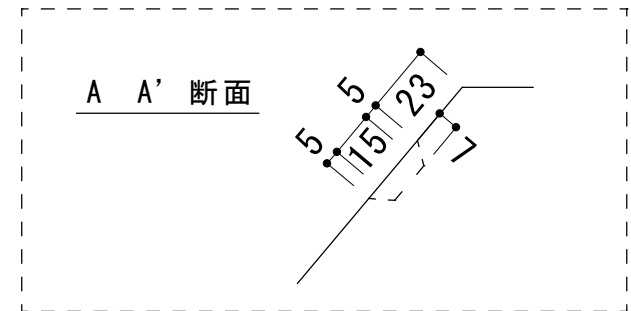
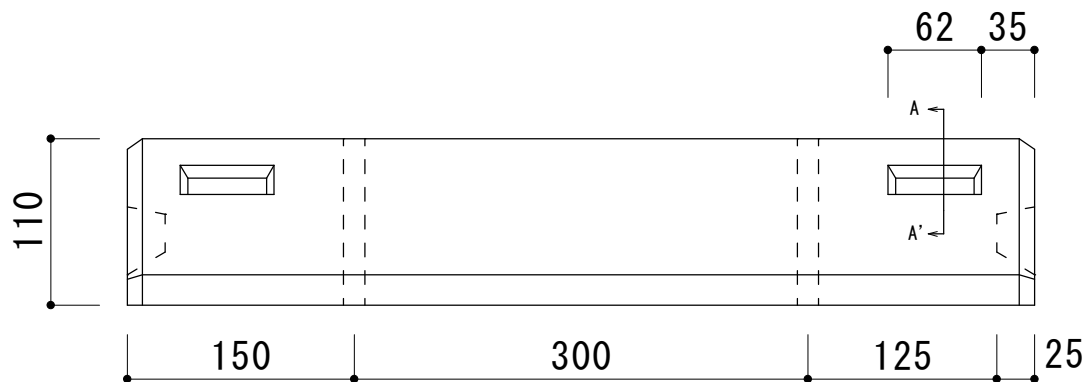
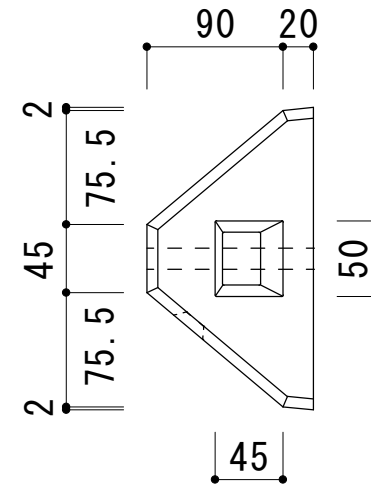
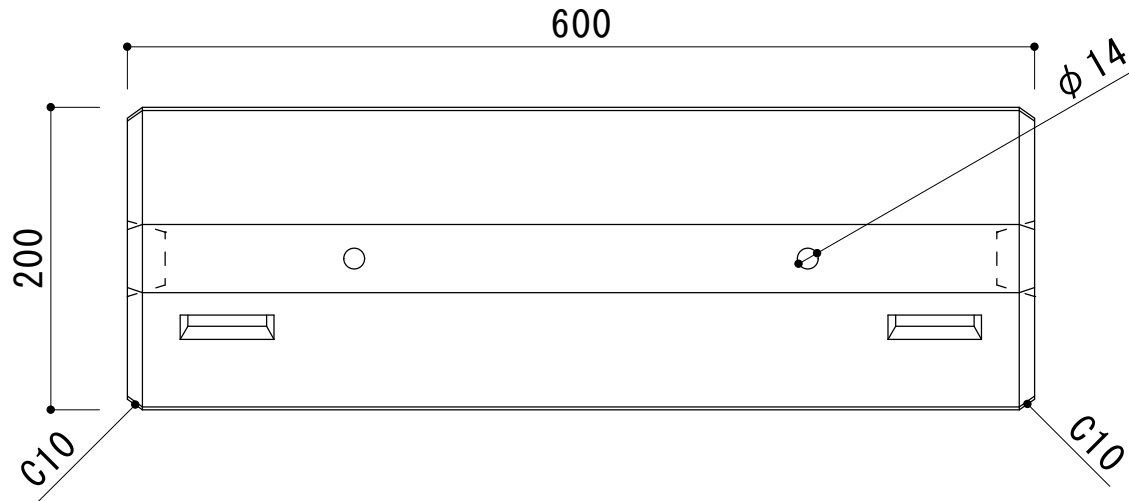
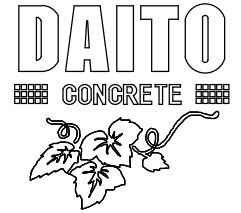

品名	ストッパー R (オーテックス)
寸法 (mm)	200 × 600 × 110
重量	19kg